

Igor Konieczniak¹, Rupesh Kumar¹, Gerald Bonner², Tim Spiller¹

¹ Department of Physics, University of York, Heslington, York YO10 5DD, UK
² Fraunhofer Centre for Applied Photonics, 99 George Street, Glasgow, G1 1RD, UK

igor.konieczniak@york.ac.uk, rupesh.kumar@york.ac.uk

Motivation

Quantum Key Distribution (QKD) over a free-space channel is challenging due to inefficient coupling of received signals to the detection system. A narrow detector cross-section, such as with fibre coupling to a telescope, reduces the field of view (FOV) and thus increases the loss due to atmospheric turbulence. With a large-area detector, one can design the signal collection optics such that the FOV of the telescope with a given aperture can be larger, reducing the channel loss due to beam wandering and atmospheric turbulence.

CV-QKD Signal Detection

In homodyne detection for quantum signals, the signal field is mixed with a strong local oscillator (LO) field, ϵ_{lo} , on a symmetric beam splitter whose outputs are connected to PIN photo-diodes as shown in figure 1. The photo-currents are subtracted from each other and the difference is amplified to a detectable level. The amplifier output directly indicates the quadrature of the input signal where the relative phase of the LO with respect to the signal determines the quadrature under measurement

Homodyne detection (HD)

Signal field

- X and P are quadratures of the signal,
- θ_s is its phase.

$$\epsilon_s = (X + iP)e^{i\theta_s}$$

LO field

- I_{lo} is the intensity of the LO,
- θ_{lo} is its phase.

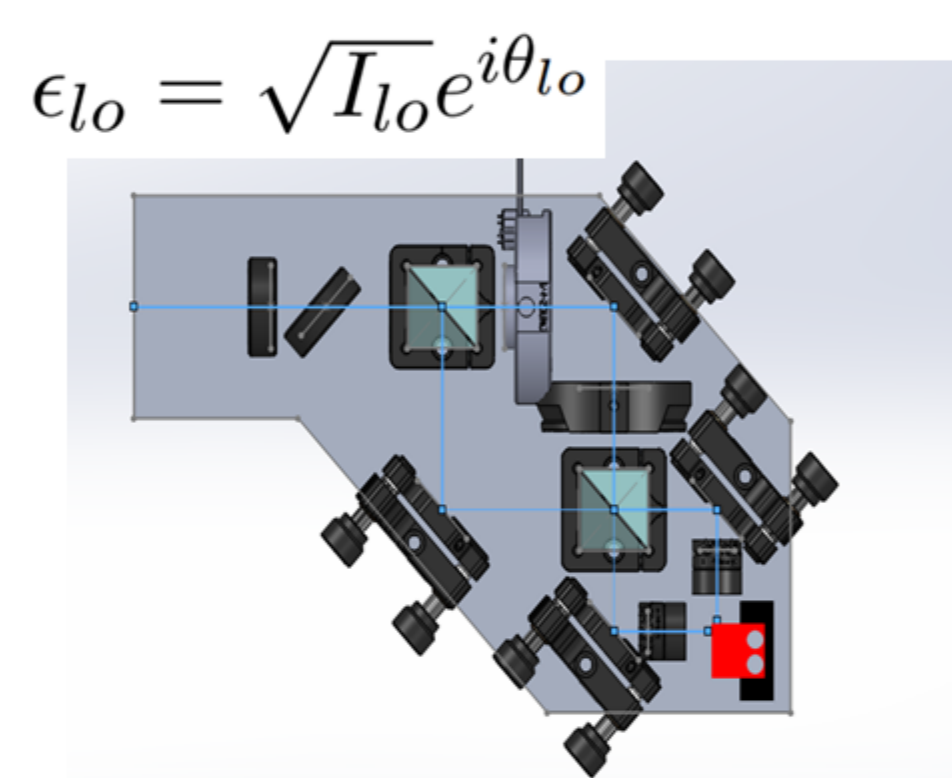
$$\epsilon_{lo} = \sqrt{I_{lo}}e^{i\theta_{lo}}$$

Output

- $X_{\theta_{lo}}$ is the signal quadrature relative to the LO
- X_0 is the quadrature component from the shot noise variance
- X_{ele} the contribution from electronic noise.

$$HD_{out} = 2\sqrt{I_{lo}}(X_{\theta_{lo}} + X_0) + X_{ele}$$

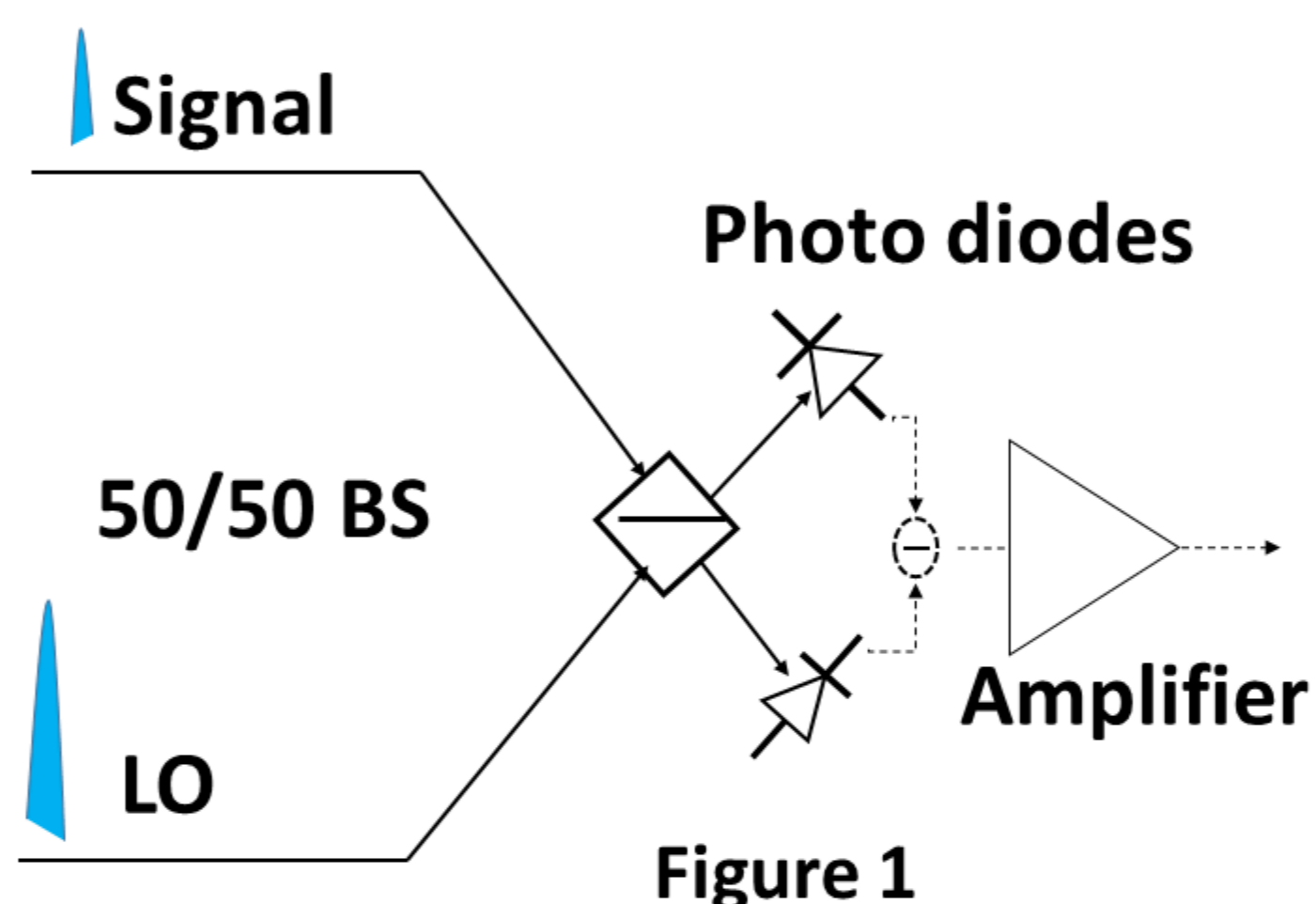

Large area Photodiode in HD

A homodyne detector can be made vacuum noise sensitive by either increasing the LO power or using comparatively low electronic noise components. Increasing the area of the photodiode has following effect in homodyne detection:

Disadvantages

- Decreases the bandwidth
- Increases the electronic noise

Advantages

- Increases the field of view
- Increases signal collection efficiency

Bandwidth

A photodiode with a larger area A has a greater capacitance which, in turn, diminishes its bandwidth B.

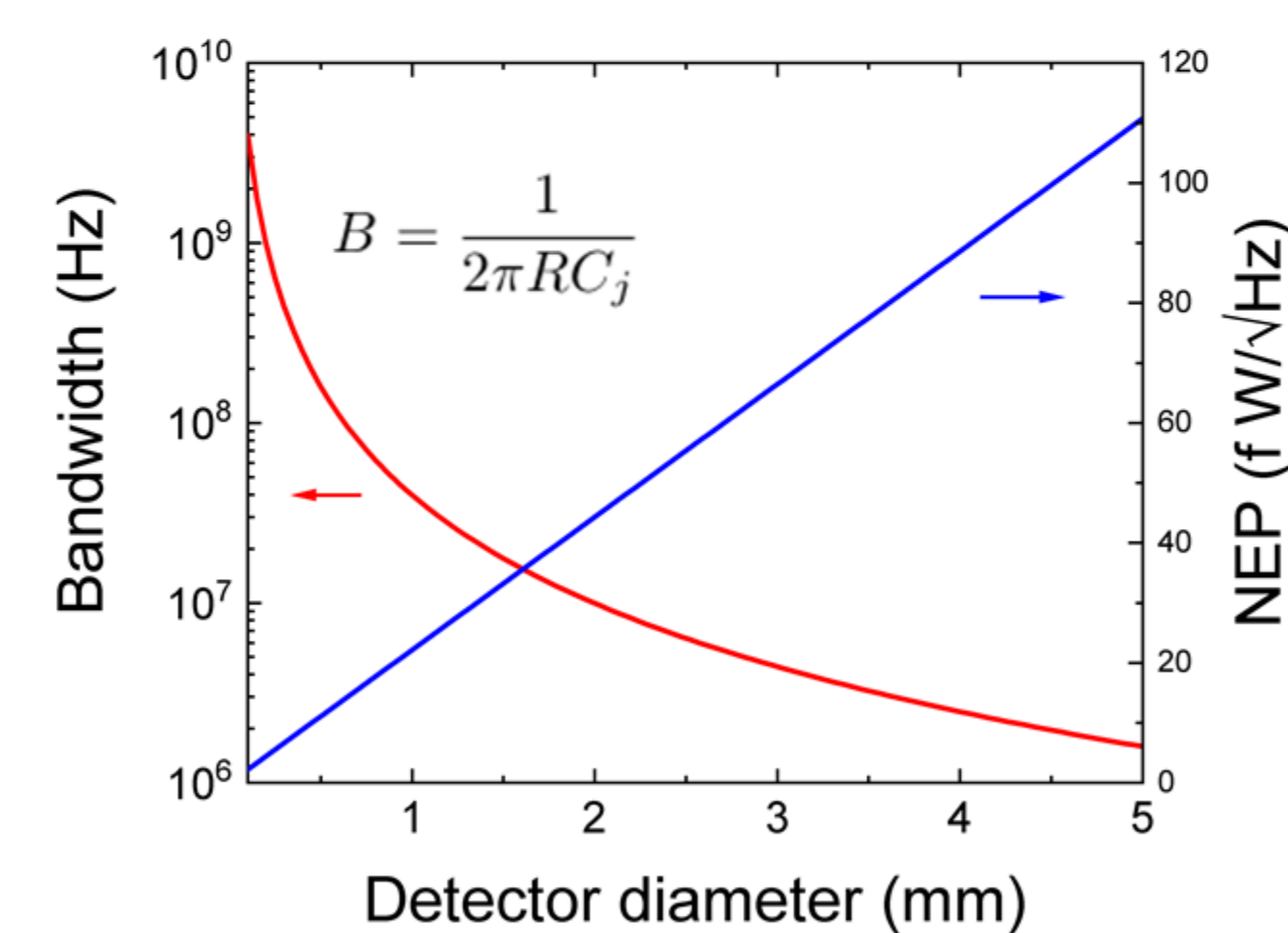

Electronic Noise

Even with a high bandwidth amplifier, the detector continues to operate in the shot noise limited regime.

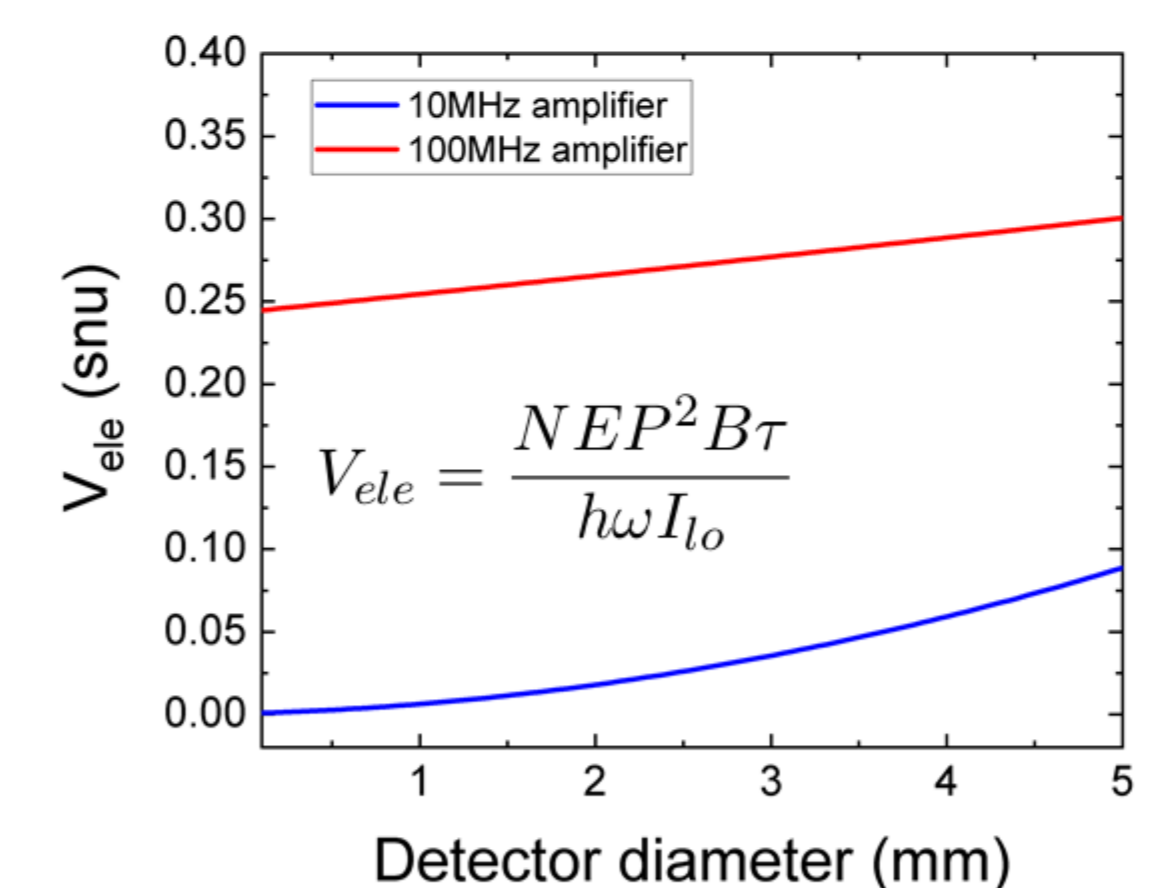

Turbulence

Simulation of the turbulence effect on the intensity profile hitting the core of a fibre. Photodiodes can have much larger dimensions (1-5 mm).

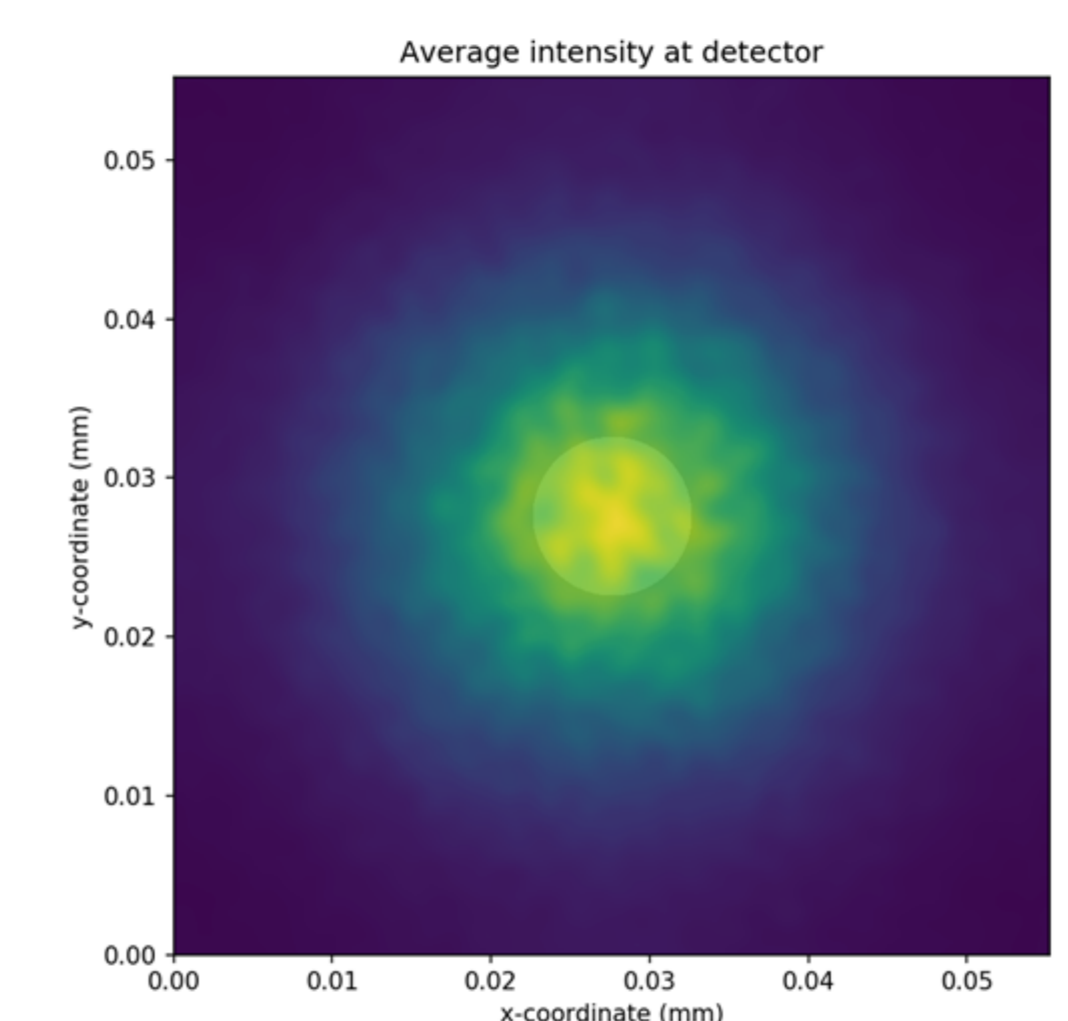

Field of view

A larger detector allows for increased field of view, rendering the system less sensitive to misalignment.

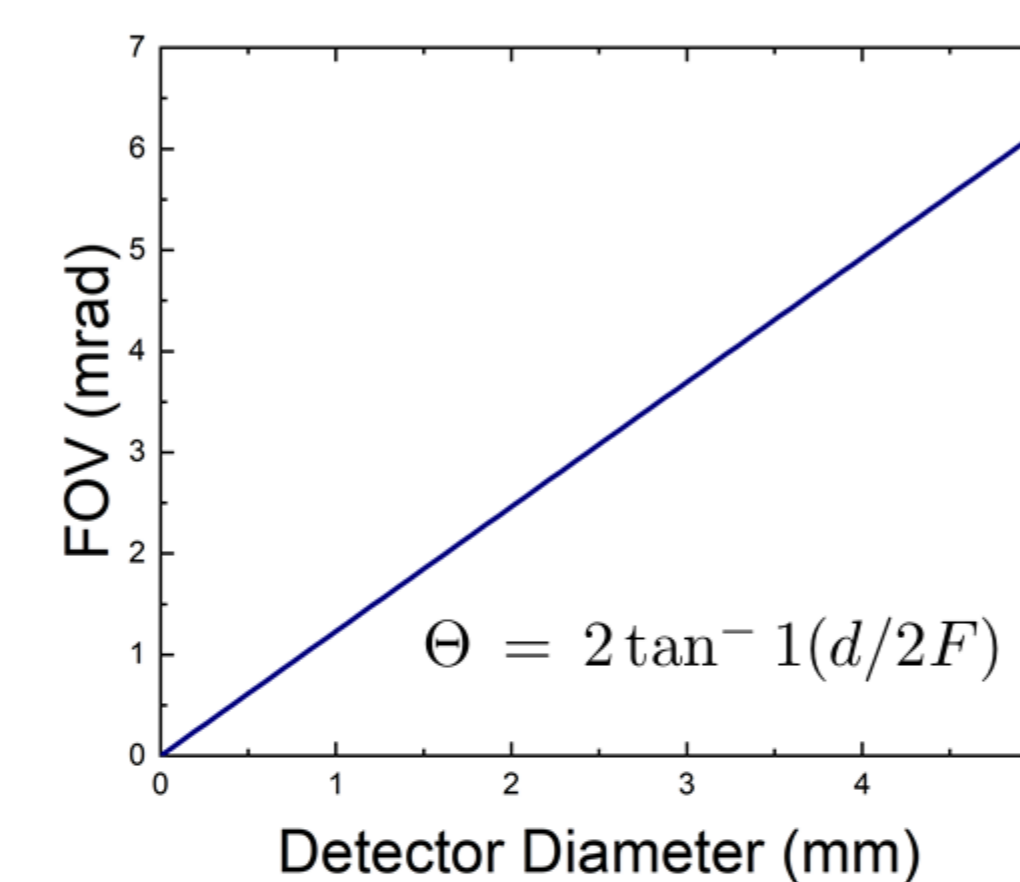

Shot noise variance vs LO power

First shot noise measurements of the detector.

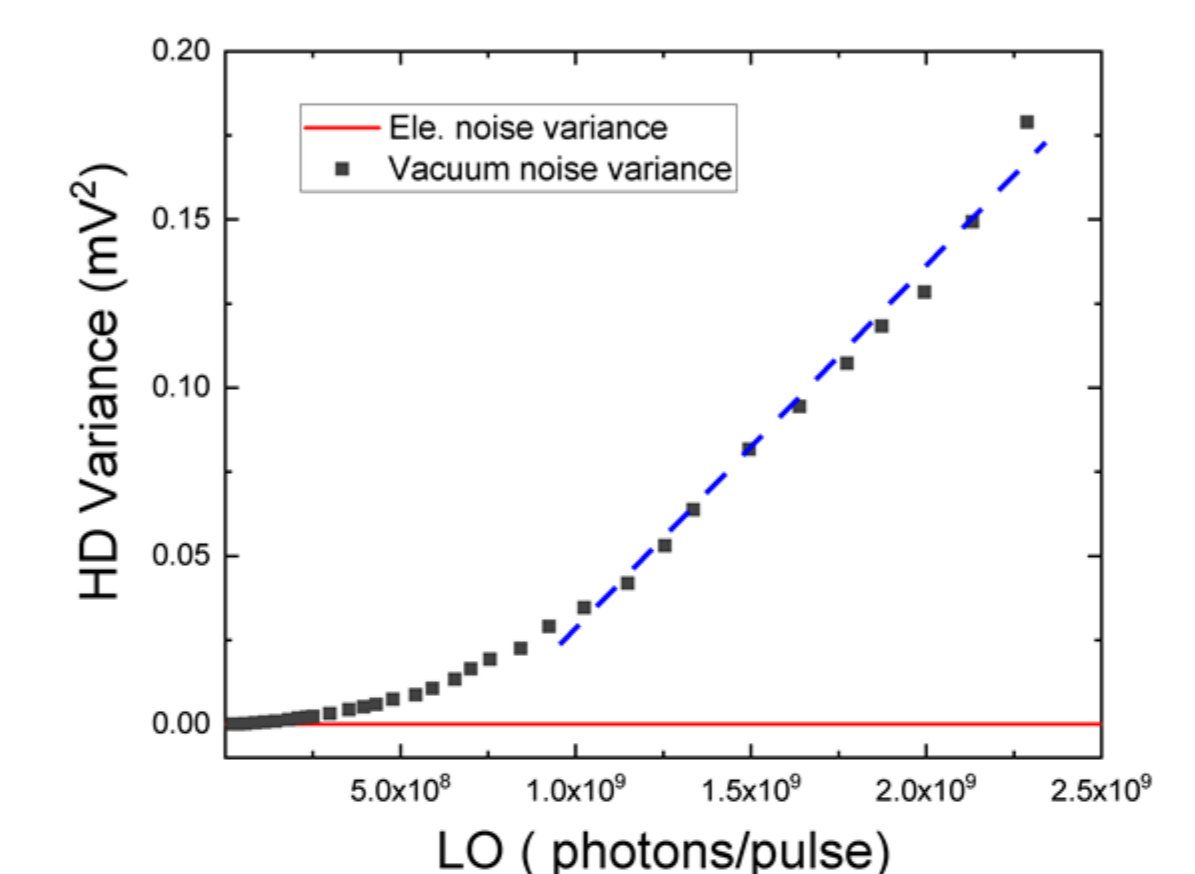

Conclusions

- Large area photodiodes increase signal collection efficiency of a homodyne detector in free-space channels under turbulence.
- Increasing the FOV → relaxing pointing and tracking accuracy
- Detection bandwidth is reduced but insignificant effect in typical CVQKD transmission rate.